

800 Watt Medical



Features

- 5 x 8.5 x 1.61 inches
- Approval to EN60601 3rd Edition
- Dual Fusing
- Current Sharing Option
- Peak Power Capability
- Standard IEC60601-1-2 : 2014 (4th Edition)
- 5 V Stand by Provision

Electrical Specifications

Input Voltage	85–264 VAC/120–390 VDC, Universal	
Input Frequency	47–63 Hz	
Input Current	120 VAC: 8 A max.	240 VAC: 3.64 A max.
Input Protection	F16A/250 V in Live & Neutral both	
No Load Power	Typ 3W over entire input range with main output kept off using Remote ON/OFF Typ 6W over entire input range with main output kept on using Remote ON/OFF	
Inrush Current	240 VAC: 25 A max.	
Leakage Current	400 μ A @ 240 VAC / 50 Hz	Touch Current : < 100 μ A
Efficiency	120 VAC: 88% Typical 240 VAC: 93%	
Hold-up Time	120 VAC: 8 ms	240 VAC: 8 ms
Power Factor	120 VAC: 0.98 240 VAC: 0.95	
Output Power	Forced Air Cooling, up to 800W (U-Channel), up to 560W (Slotted Cover), up to 480W (Plain Cover) * Ref. Derating curve	
Line Regulation	+/-0.5%	
Load Regulation	+/-1%	
Transient Response	< 10%, 50% to 100% load change, 50 Hz, 50% duty cycle, 0.1 A/ μ s, recovery time < 5 ms	
Rise Time	<100ms	
Set Point Tolerance	+/-1%	
Output Adjustability	+/-3%	
Over Current Protection	110% Typ, HiccUp Type, Autorecovery	
Over Voltage Protection	114%, Latch Type, AC Power to be recycled for recovery	
Short Circuit Protection	Latch Type, AC Power to be recycled for recovery	
Over Temperature Protection	130-140°C primary heat sink, autorecovery	
Current Share	Upto 3 supplies can be connected in parallel (optional)	
Switching Frequency	PFC converter:Variable, 85 kHz typical Resonant converter:Variable, 100 kHz typical	
Operating Temperature	–40 to +70°C, refer derating curve	
Storage Temperature	–40 to +85°C	
Relative Humidity	95% Rh, noncondensing	
Altitude	Operating: 16,000 ft.; Nonoperating: 40,000 ft.	
MTBF	1.28m Hours, Telcordia -SR332-issue 3	
Isolation Voltage	Input to Output 4245 VAC, Input to Earth 1625 VAC, Output to Earth 1500 VAC	

Model Number	Type	Voltage	Max. Load (Convection)	Max. Load (300 LFM) (Fan Cooled)	Min. Load	Ripple ¹
MVPS800-1012	U-Channel	12 V	25 A	33.33 A	0.0 A	2%
MVPS800-1015	U-Channel	15 V	25 A	33.33 A	0.0 A	2%
MVPS800-1024	U-Channel	24 V	25 A	33.33 A	0.0 A	2%
MVPS800-1030	U-Channel	30 V	20 A	26.66 A	0.0 A	2%
MVPS800-1048	U-Channel	48 V	12.5 A	16.66 A	0.0 A	2%
MVPS800-1058	U-Channel	58 V	10.34 A	13.78 A	0.0 A	2%
MVPS800-1S12	U-Channel + Slotted	12 V	17.5 A	23.33 A	0.0 A	2%
MVPS800-1S15	U-Channel + Slotted	15 V	17.5 A	23.33 A	0.0 A	2%
MVPS800-1S24	U-Channel + Slotted	24 V	17.5 A	23.33 A	0.0 A	2%
MVPS800-1S30	U-Channel + Slotted	30 V	14 A	18.66 A	0.0 A	2%
MVPS800-1S48	U-Channel + Slotted	48 V	8.75 A	11.66 A	0.0 A	2%
MVPS800-1S58	U-Channel + Slotted	58 V	7.25 A	9.66 A	0.0 A	2%
MVPS800-1T12	U-Channel + Cover	12 V	15 A	20 A	0.0 A	2%
MVPS800-1T15	U-Channel + Cover	15 V	15 A	20 A	0.0 A	2%
MVPS800-1T24	U-Channel + Cover	24 V	15 A	20 A	0.0 A	2%
MVPS800-1T30	U-Channel + Cover	30 V	12 A	16 A	0.0 A	2%
MVPS800-1T48	U-Channel + Cover	48 V	7.5 A	10 A	0.0 A	2%
MVPS800-1T58	U-Channel + Cover	58 V	6.2 A	8.26 A	0.0 A	2%

To order product with the redundancy diode option please add the suffix-R to your required part number. For Example - MVPS800-1012-R

Connectors		
J1	1	AC LINE
	2	NEUTRAL
	3	EARTH
J2	J2-A	+VE
	J2-B	-VE
J3	Pin 1	GND
	Pin 2	5V AUX
	Pin 3	PGPF
	Pin 4	VS -
	Pin 5	VS +
	Pin 6	GND
	Pin 7	RMT
	Pin 8	CL2
	Pin 9	CL1
	Pin 10	LS
J10,J11 (FAN OUTPUT)	Pin 1	+ VE
	Pin 2	- VE



Innovations in Power

Notes

1. For Ripple measurement minimum output power requirement is 25 W.

Ripple is peak to peak with 20 MHz bandwidth and 10 μ F (Tantalum capacitor) in parallel with a 0.1 μ F capacitor at rated line voltage and load ranges.

2. Combined output power of main output, fan supply and standby supply shall not exceed max. power rating.

3. Standby output voltage 5 V/ 1.5A(convection) with tolerance including set point accuracy, line and load regulation is +/-10%.

Ripple and noise is less than 5%.

4. Specifications are for nominal input voltage, 25°C unless otherwise stated.

5. PSU is supplied with J3, pin-6 and pin-7 shorted to enable main output without remote on/off feature.

6. Fan supply output voltage 12V/500ma is +/-30% and ripple less than 10% to get 12V output min 10% load on main output is required.

Mechanical Specifications

AC Input Connector (J1)	TE Connectivity: NC6-P107-03
DC Output Connector (J2)	6-32 inches Screw Pan HD Mating: Designed to accept Ring Tongue Terminal AMP : 8-31886-1, wherein one 16 AWG(max) wire can be crimped. Note : One Ring Tongue Terminal with 16 AWG is recommended for current upto 11A only. Use multiple tongue terminals with wire for more current.
Signal Connector (J3)	Molex: 22-23-2101 Mating: 22-01-2107; Pins: 08-50-0113
Dimensions	5.0 x 8.5 x 1.61 inches (127 x 216 x 41 mm)
Weight	1.1 kg

EMC

Parameter	Conditions/Description	Criteria
Conducted Emissions	EN 55011-B,CISPR22-B, FCC PART15-B	Class B
Radiated Emissions	EN 55011	Class A (Class B with external toroid)
Input Current Harmonics	EN 61000-3-2	Class A
Voltage Fluctuation and Flicker	EN 61000-3-3	Complies
ESD Immunity	EN 61000-4-2	A
Radiated Field Immunity	EN 61000-4-3	A
Electrical Fast Transient Immunity	EN 61000-4-4	A
Surge Immunity	EN 61000-4-5	A
Conducted Immunity	EN 61000-4-6	A
Magnetic Field Immunity	EN 61000-4-8	A
Voltage dips, interruptions	EN 61000-4-11	A & B

Safety

CE Mark	Complies with LVD Directive
Approval Agency	Nemko, UL, C-UL
Safety Standard(s)	EN60601-1, IEC 60601-1 (ed.3),ANSI/AAMI ES 60601-1, CSA C22.2 No. 60601-1
Safety File Number(s)	UL Certificate No : 2019-02-21-E173812 CB Test Certificate No : NO105338 Nemko Certificate No : P19223365

Signal(s)

Power Good / Power Fail Signal

Power Good : Is a TTL signal which goes high after main output reaches 90% of its set value.

The delay is 0.1 s to 0.5 s

Power Fail : The same signal goes low at least 1ms before main output falls to 90% of set value at AC Power off

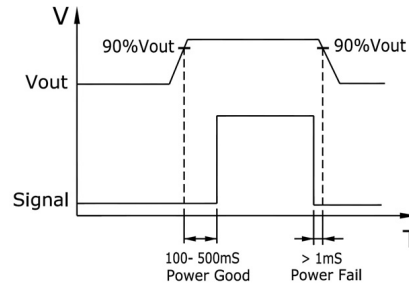

Remote Sense

Compensates for 200 mV drop

Remote on/off

Pin 6 & Pin 7 of J3 can be used for Remote on/off.

Shorting Pin 6 to Pin 7 enables main output while keeping the pins open disables main output

OCP limit set

Pin 8 & Pin 9 of J3 must be left open

Derating Curve

De-rating Curve 12V

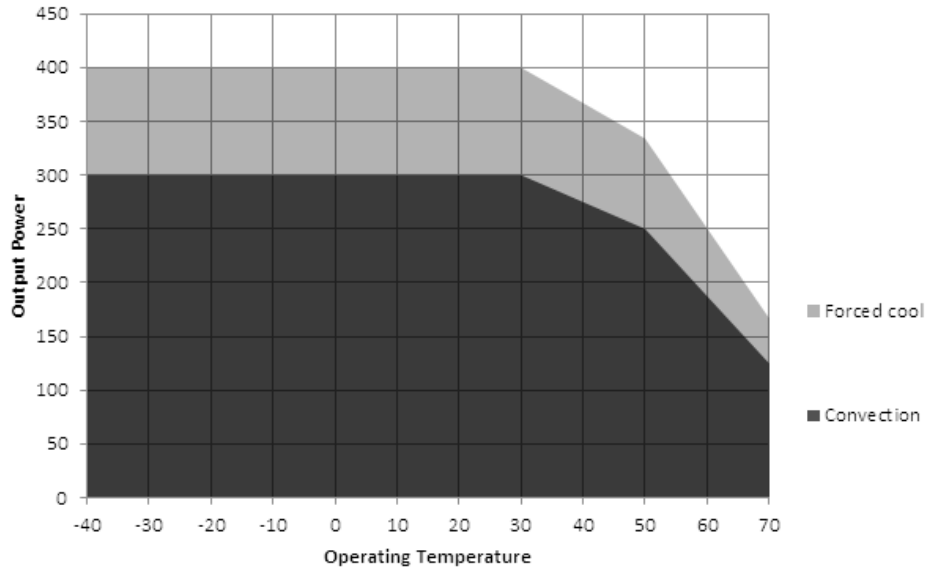

De-rating Curve- 12V for slotted cover

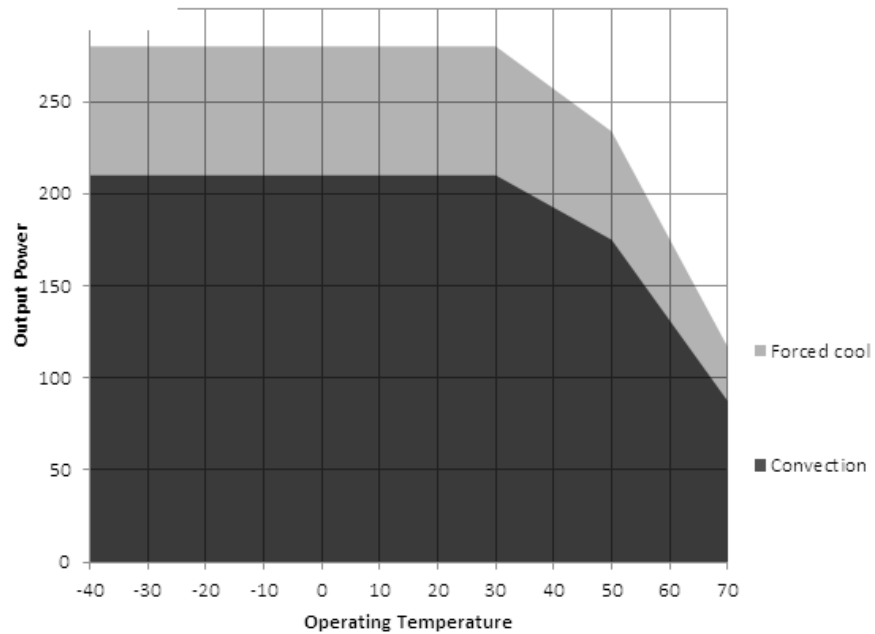

Derating Curve

De-rating Curve- 12V for plain cover

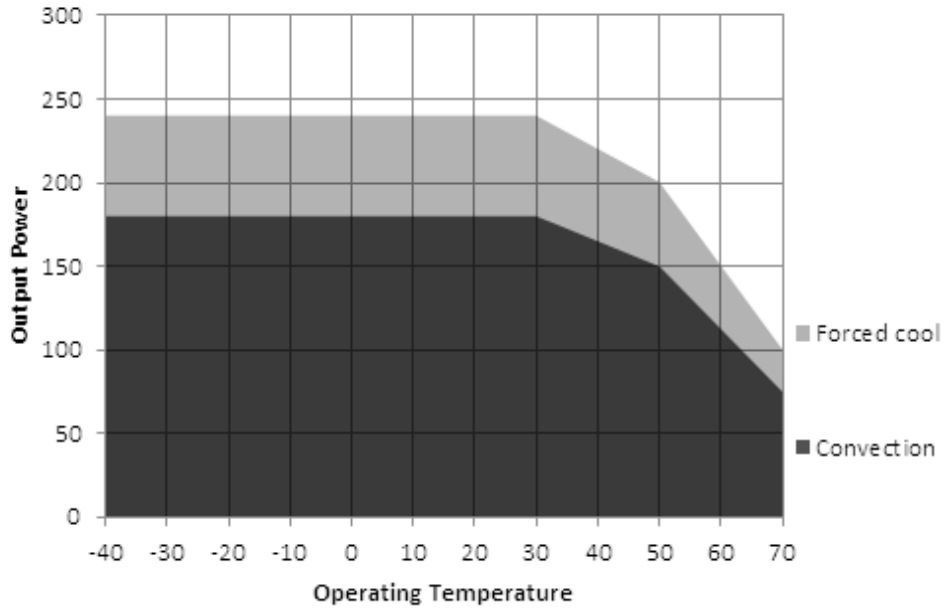

De-rating Curve 15V

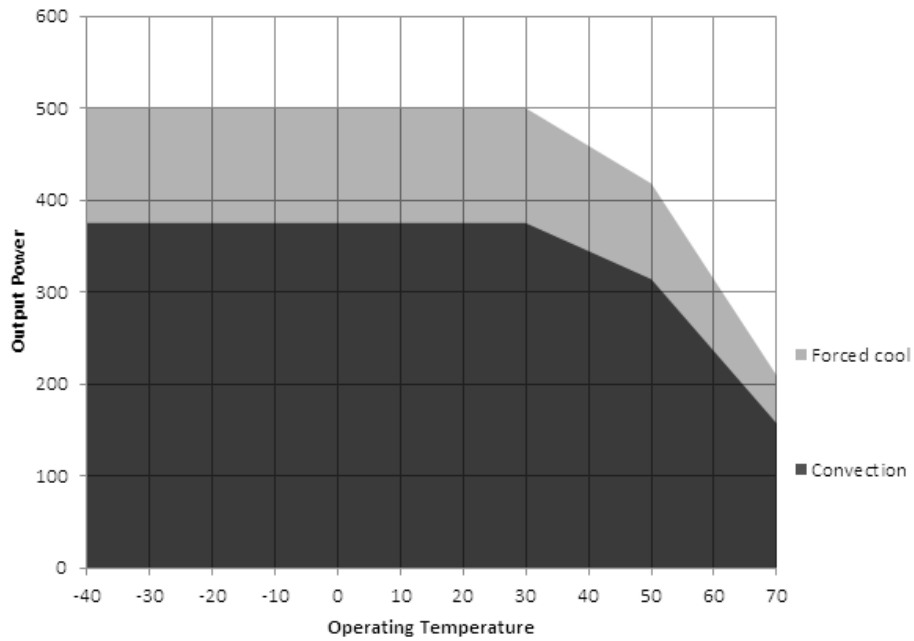

Derating Curve

De-rating Curve- 15V for slotted cover

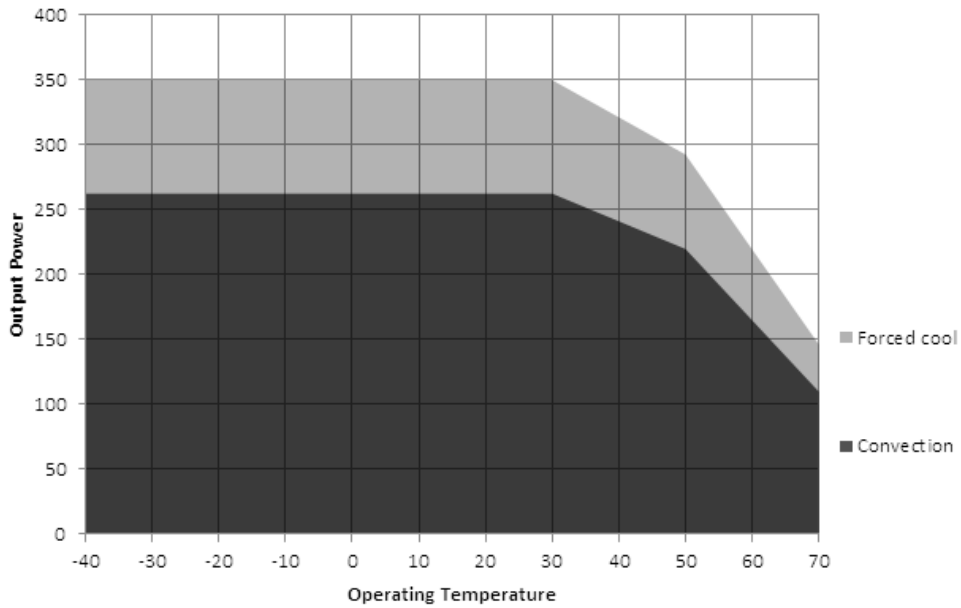

De-rating Curve- 15V for plain cover

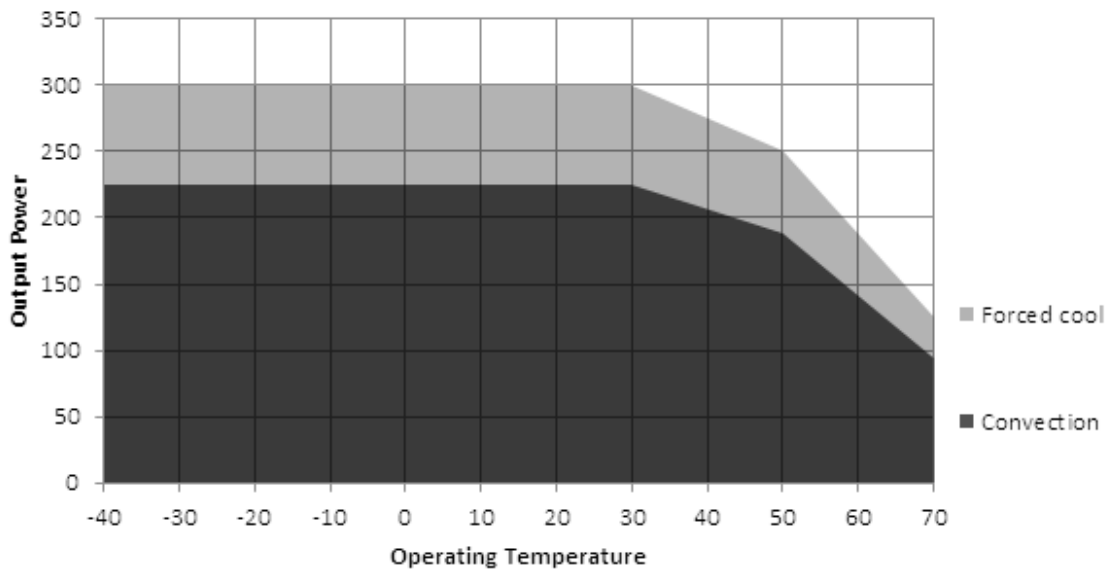

Derating Curve

De-rating Curve- 24V & above

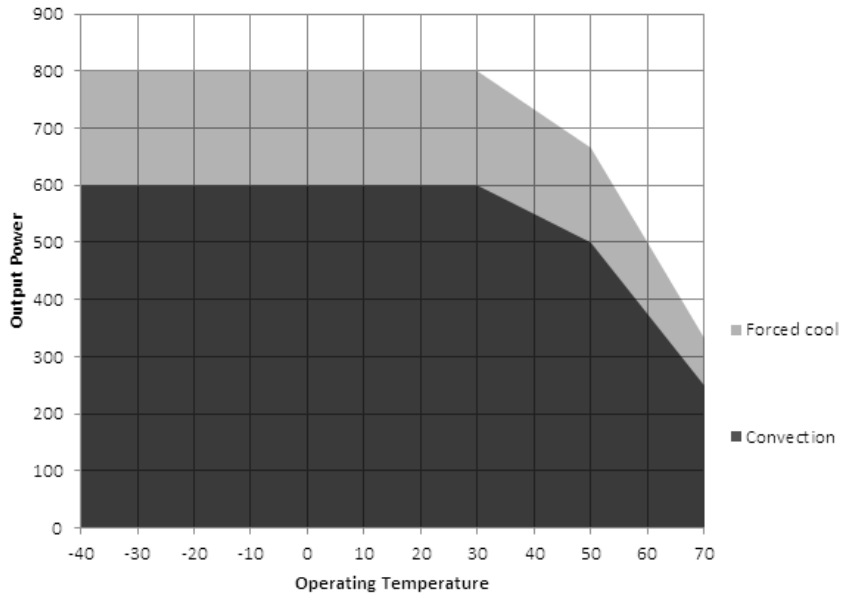

De-rating Curve- 24V & above for slotted cover

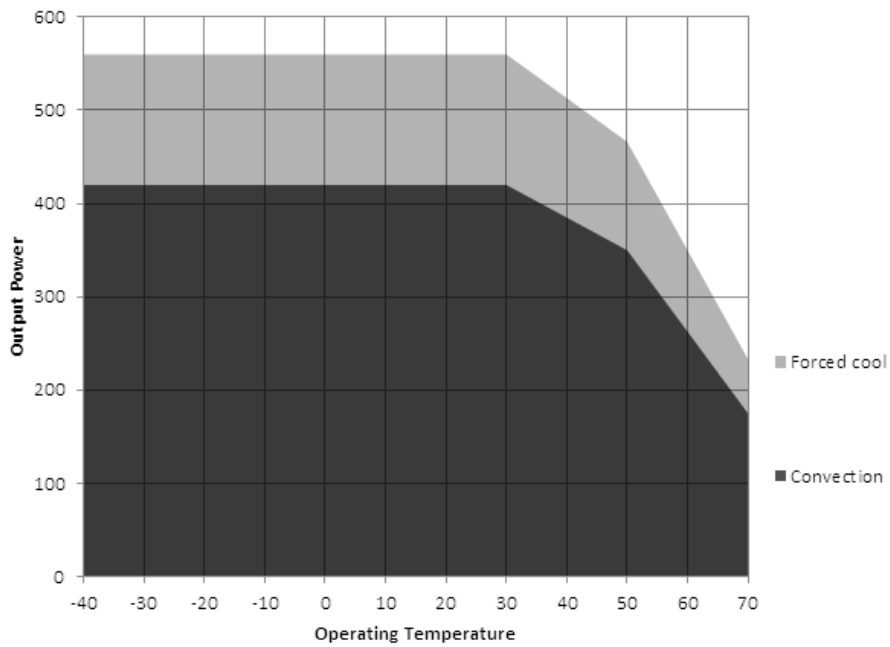

Derating Curve

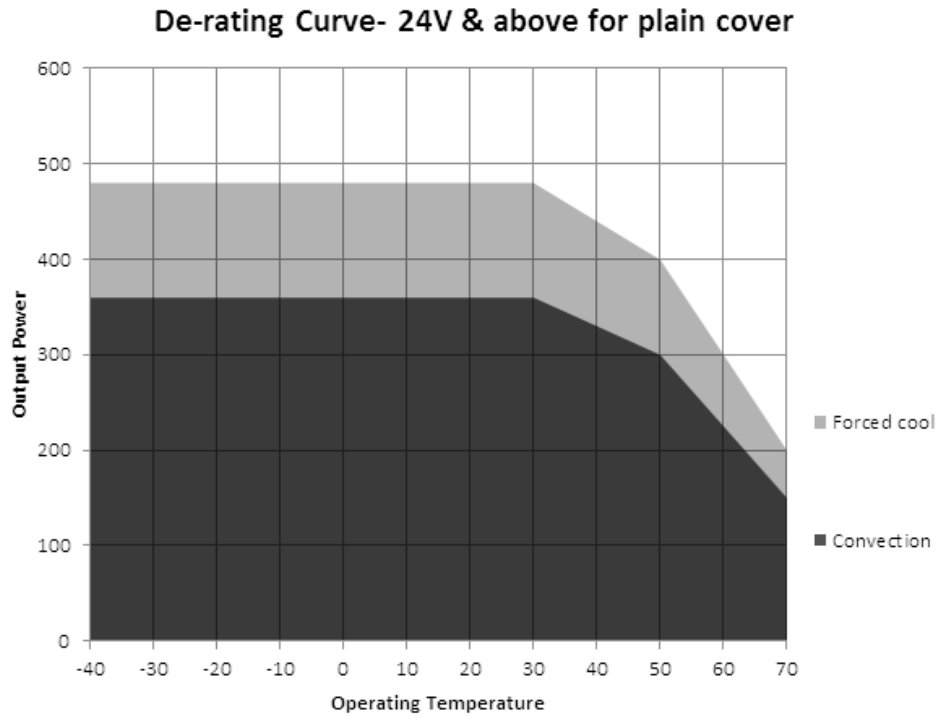

Mechanical Drawing

Option - 1 (U-Channel)

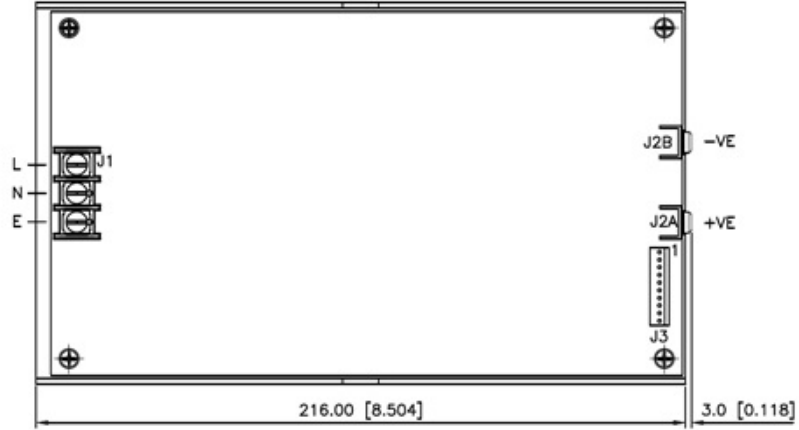
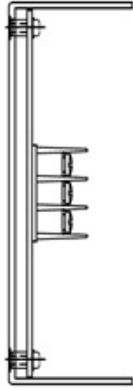

TOP VIEW

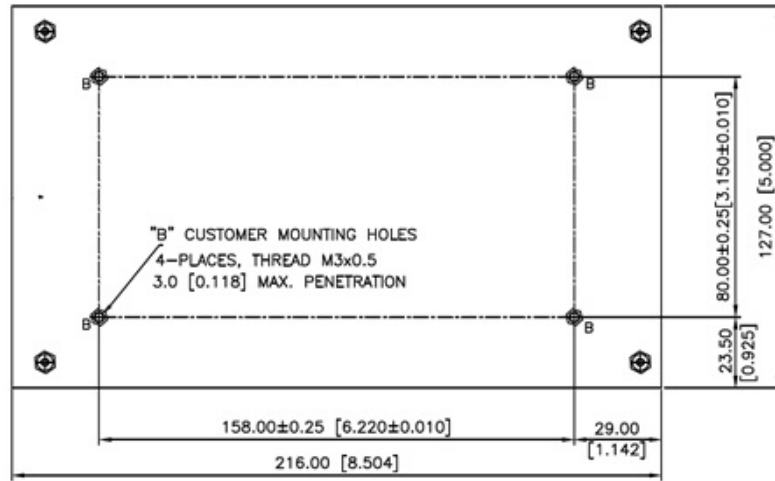

BOTTOM VIEW

MECHANICAL OUTLINE DIMENSIONS
 ALL DIMENSIONS ARE IN MM [INCHES]
 GEN.TOLERANCE:±1.0 MM [±0.04]

Mechanical Drawing

Option - 2 (Slotted Cover)

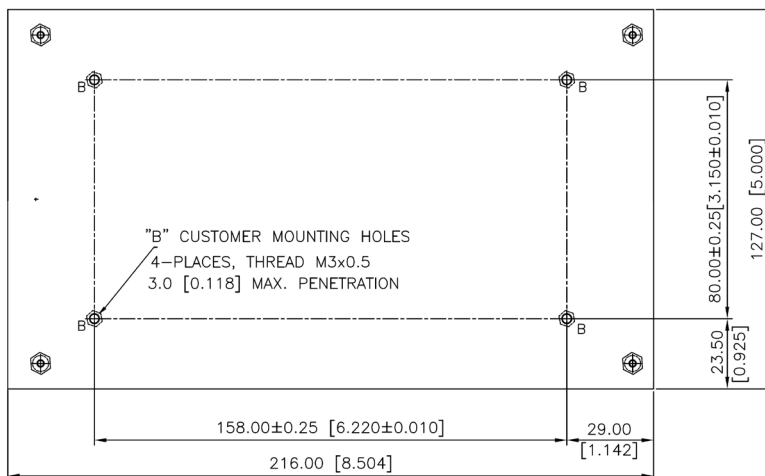
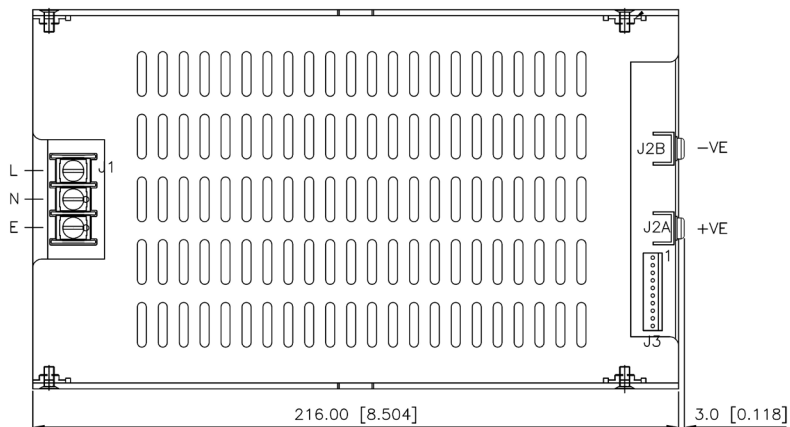
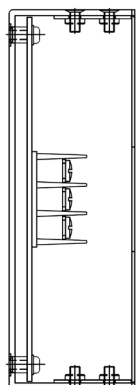

BOTTOM VIEW

MECHANICAL OUTLINE DIMENSIONS
ALL DIMENSIONS ARE IN MM [INCHES]
GEN.TOLERANCE:±1.0 MM [±0.04]



Innovations in Power

Mechanical Drawing

Option - 3 (Plain Cover)

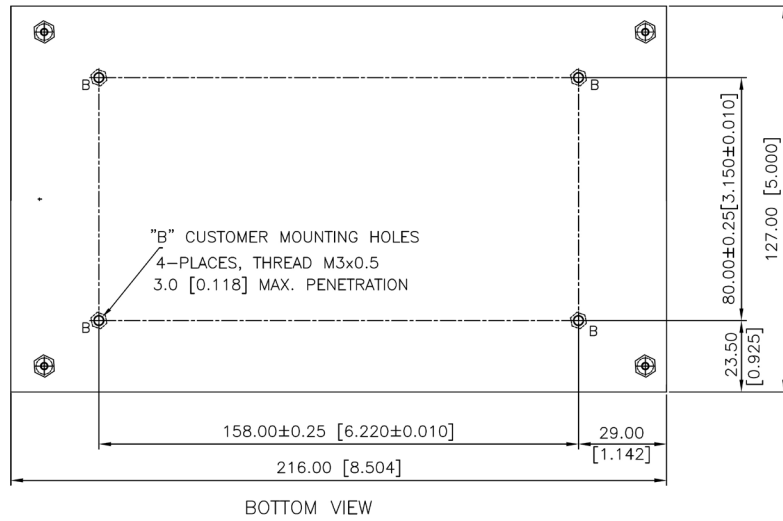
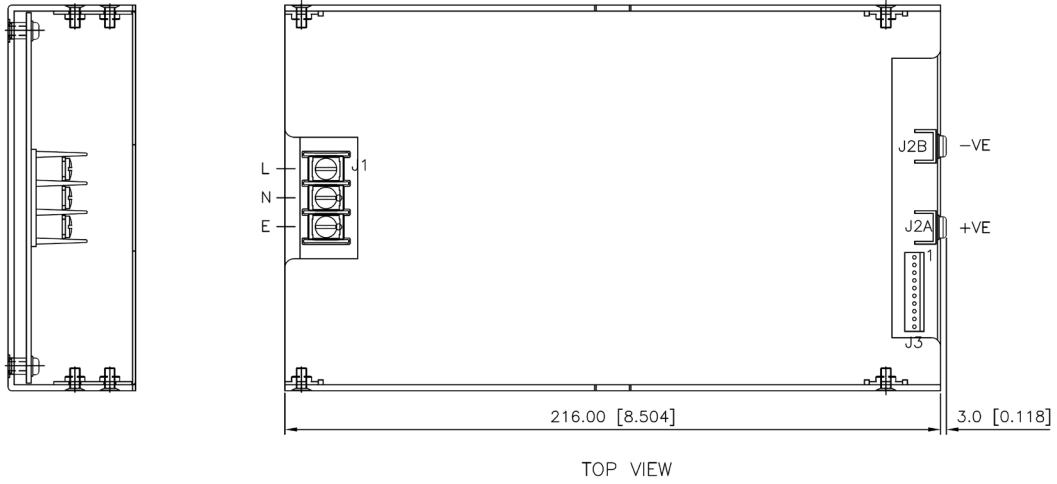

MECHANICAL OUTLINE DIMENSIONS
ALL DIMENSIONS ARE IN MM [INCHES]
GEN.TOLERANCE: ±1.0 MM [±0.04]

Installation instruction for current sharing:

During the installation and setup of parallel supplies in a system it is important that a single remote sense point be used for all the supplies. The remote sense voltage between the supplies must be adjusted to within 1% to ensure the supplies are inside the 1% capture window. If the supplies are not initially adjusted inside the capture window the supplies will not current share satisfactorily.

Set-Up Procedures:

1. Connect load cables to the outputs of each supply.
2. Connect the remote sense lines to the load in twisted style . (A common remote sense point must be used for all the supplies in parallel).
3. Connect all the "LS" signal(Pin 10) on the J3 connector between the supplies.
4. Adjust remote sense voltage of each supply to within 1% of rated output voltage or readjust to required set point. (Adjustment to be done with all other parallel supplies off).
5. Current sharing between the supplies can be verified by monitoring the output current of each supply with a hall effect DC current probe. The supplies should share to within 10% of the total load current.
6. The current share circuit has a capture window voltage of +/- 1% of the rated output voltage. If the output remote sense voltage of one of the supplies is adjusted outside the 1% window the supplies will not current share satisfactorily.

CURRENT SHARING BLOCK DIAGRAM

