

# 180 Watt Industrial

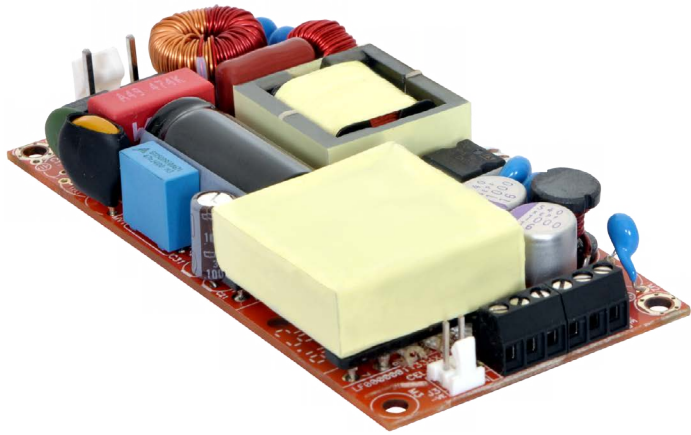

## Features

- 4 x 2 x 0.75 Inches Form factor
- 180 Watts with Forced Air Cooling
- Efficiencies upto 92%
- -40 to 70 degree operating temperature\*
- 12V / 0.5A Fan Output, Thermal Shut-Down feature
- 3.37m Hours, Telcordia -SR332-issue 3 MTBF
- No Load Power < 0.5W

## Electrical Specifications

Input Voltage	80-264 VAC/390 VDC, Universal (Derate from 100% at 100V AC to 77% at 80V AC)	
Input Frequency	47-63 Hz	
Input Current	115 VAC: 2.2 A max.	230 VAC: 1.1 A max.
No Load Power	<0.5W typical for ULP180-1XXX and <0.85W typical for ULP180-0XXX	
Inrush Current	115 V AC – 25 A, 230 VAC – 45 A, 264 VAC – 75 A	
Leakage Current	300 uA Typical, (N.A. For Class II Option)	Touch current <100uA
Efficiency	92%(48V,58V), 90%(24V,30V), 88%(12V,15V)	
Hold-up Time	at 180W:10 ms ; 120W: 16 ms	
Power Factor	>0.95@115 VAC and 0.9@230 VAC	
Output Power	180W with 13 CFM, upto 120W Convection	
Line Regulation	+/-0.5%	
Load Regulation	+/-1%	
Transient Response	25% step load change, at 0.1A/uS slew rate, 50% duty cycle, 50Hz=4% , recovery time < 5 ms	
Rise Time	55ms typical	
Set Point Tolerance	+/-1%	
Output Voltage adjustment	+/-3% (Ref. Note 9)	
Over Current Protection	>110%	
Over Voltage Protection	110 to 140%	
Short Circuit Protection	Hiccup mode	
Switching Frequency	PFC – 70 to 130 KHz ,PWM – 50-80 KHz	
Operating Temperature <sup>7</sup>	- 40 to +70°C, * -40 to 0°C startup is guaranteed with spec deviation	
Storage Temperature	-40 to +85°C	
Relative Humidity	5% to 95%, noncondensing	
Altitude	Operating: 16,000 ft.; Nonoperating: 40,000 ft.	
MTBF	3.37m Hours, Telcordia -SR332-issue 3	
Isolation Voltage	Input to Output – 3000V AC for ITE application Input to GND - 1500 VAC (Not Applicable For Class II Option)	
Cooling	180W with 13 CFM forced air cooling <sup>6</sup> (refer Mechanical Drawing) upto 120 W with natural convection cooling <sup>6</sup> (refer Derating Curve)	

Model Number	Description	Voltage	Max. Load (Convection) (112.5W) @50°C	Max. Load (Convection) (120W) @40°C	Max. Load (13 CFM)	Min. Load	Ripple <sup>1</sup>	Signal
ULP180-1012	with Screw Terminal	12 V	9.37A	10.00A	15.00A	0.0 A	2%	N.A
ULP180-1312	with Molex Connector	12 V	9.37A	10.00A	15.00A	0.0 A	2%	N.A
ULP180-1015	with Screw Terminal	15 V	7.50A	8.00A	12.00A	0.0 A	2%	N.A
ULP180-1315	with Molex Connector	15 V	7.50A	8.00A	12.00A	0.0 A	2%	N.A
ULP180-1024	with Screw Terminal	24 V	4.68A	5.00A	7.50A	0.0 A	1%	N.A
ULP180-1324	with Molex Connector	24 V	4.68A	5.00A	7.50A	0.0 A	1%	N.A
ULP180-1030	with Screw Terminal	30 V	3.75A	4.00A	6.00A	0.0 A	1%	N.A
ULP180-1330	with Molex Connector	30 V	3.75A	4.00A	6.00A	0.0 A	1%	N.A
ULP180-1048	with Screw Terminal	48 V	2.34A	2.50A	3.75A	0.0 A	1%	N.A
ULP180-1348	with Molex Connector	48 V	2.34A	2.50A	3.75A	0.0 A	1%	N.A
ULP180-1058	with Screw Terminal	58 V	1.94A	2.07A	3.10A	0.0 A	1%	N.A
ULP180-1358	with Molex Connector	58 V	1.94A	2.07A	3.10A	0.0 A	1%	N.A
ULP180-CK metal cover kit accessory								
ULP180-0012	with Screw Terminal	12 V	9.37A	10.00A	15.00A	0.0 A	2%	PG & AC PF <sup>11</sup>
ULP180-0312	with Molex Connector	12 V	9.37A	10.00A	15.00A	0.0 A	2%	PG & AC PF <sup>11</sup>
ULP180-0015	with Screw Terminal	15 V	7.50A	8.00A	12.00A	0.0 A	2%	PG & AC PF <sup>11</sup>
ULP180-0315	with Molex Connector	15 V	7.50A	8.00A	12.00A	0.0 A	2%	PG & AC PF <sup>11</sup>
ULP180-0024	with Screw Terminal	24 V	4.68A	5.00A	7.50A	0.0 A	1%	PG & AC PF <sup>11</sup>
ULP180-0324	with Molex Connector	24 V	4.68A	5.00A	7.50A	0.0 A	1%	PG & AC PF <sup>11</sup>
ULP180-0030	with Screw Terminal	30 V	3.75A	4.00A	6.00A	0.0 A	1%	PG & AC PF <sup>11</sup>
ULP180-0330	with Molex Connector	30 V	3.75A	4.00A	6.00A	0.0 A	1%	PG & AC PF <sup>11</sup>
ULP180-0048	with Screw Terminal	48 V	2.34A	2.50A	3.75A	0.0 A	1%	PG & AC PF <sup>11</sup>
ULP180-0348	with Molex Connector	48 V	2.34A	2.50A	3.75A	0.0 A	1%	PG & AC PF <sup>11</sup>
ULP180-0058	with Screw Terminal	58 V	1.94A	2.07A	3.10A	0.0 A	1%	PG & AC PF <sup>11</sup>
ULP180-0358	with Molex Connector	58 V	1.94A	2.07A	3.10A	0.0 A	1%	PG & AC PF <sup>11</sup>
ULP180-CKP metal cover kit accessory								

Connectors		
J1	Pin 1	AC LINE
	Pin 2	NOT FITTED
	Pin 3	AC NEUTRAL
J2 Option 1 & 2	Pin 1,2,3	V1 +VE
	Pin 4,5,6	V1 -VE
J3	Pin 1	FAN +VE
	Pin 2	FAN -VE
J4 (For PGPF Option Only)	Pin 1	Vs
	Pin 2	PGPF
	Pin 3	GND



Innovations in Power

## Notes

1. Ripple is peak to peak with 20 MHz bandwidth and 10  $\mu\text{F}$  (Tantalum capacitor) in parallel with a 0.1  $\mu\text{F}$  capacitor at rated line voltage and load ranges.
2. Class II means without input Earth pin.
3. Combined output power of main output, fan supply shall not exceed max. Power rating.
4. Fan supply output voltage tolerance including set point accuracy, line and load regulation is  $\pm 10\%$  and Ripple and noise is less than 10%.
5. Specifications are for nominal input voltage, 25°C unless otherwise stated.
6. 180W with 13CFM forced air cooling and 120W with natural convection cooling at 100 to 264VAC.
7. Output ripple can be more than 10% of the output voltage.
8. Fusing on neutral for ITE model is optional.
9. Adjustment potentiometer is located on the SMT side of the PCB.
10. When used in Cover Kit, de-rate output power to 70 % under all operating conditions
11. A TTL signal is available at pin 2 of J4 which goes high 100-500mS after output voltage reaches 90% of set value. It goes low a minimum of 1mS before output falls below 90% of the set value, when input AC is switched off.

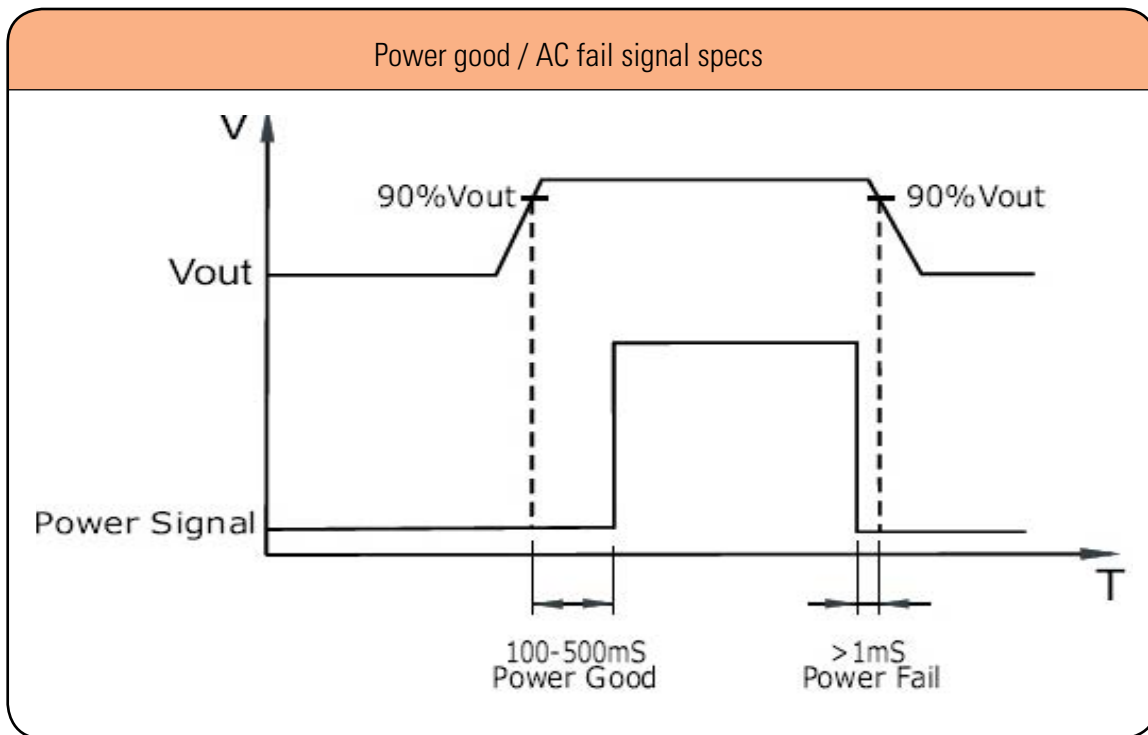

## Mechanical Specifications

AC Input Connector (J1)	Molex: 26-60-4030 Mating: 09-50-3031; Pins: 08-50-0106
DC Output Connector (J2) Option 1 (Screw Terminal)	Molex: 39357 Series or equivalent
DC Output Connector (J2) Option 2 (Molex Connector)	Molex: 26-60-4060 Mating: 09-50-3061; Pins: 08-50-0106
Aux (Fan) Output(J3)	AMP :640456-2 Mating: 640440-2
Signal Output (J4)	AMP :640456-3 Mating: 640440-3
Dimensions	4 x 2 x 0.75 inches (101.60 x 50.8x 19.05 mm)
Weight	200 gm approx

## EMC

Parameter	Conditions/Description	Criteria
Conducted Emissions	EN55032-B, CISPR22-B, FCC PART15-B	Pass
Radiated Emissions	EN 55032 A	Pass Level B with external core (King core K5B RC 25x12x15-M in input cable)
Input Current Harmonics	EN 61000-3-2	Class D
Voltage Fluctuation and Flicker	EN 61000-3-3	Pass
ESD Immunity	EN 61000-4-2	Level 3, Criterion A
Radiated Field Immunity	EN 61000-4-3	Level 3, Criterion A
Electrical Fast Transient Immunity	EN 61000-4-4	Level 3, Criterion A
Surge Immunity	EN 61000-4-5	Level 3, Criterion A
Conducted Immunity	EN 61000-4-6	Level 3, Criterion A
Magnetic Field Immunity	EN 61000-4-8	Level 3, Criterion A
Voltage dips, interruptions	EN 61000-4-11	Criterion A & B

## Safety

CE Mark	Complies with LVD Directive
Approval Agency	Nemko, UL, C-UL
Safety Standard(s)	EN60950-1, IEC60950-1 (ed.2) , UL 60950 (ed.2), CSA C22.2 No.60950-1 (ed.2), Class1 SELV
Safety File Number(s)	UL: 20161121-E150565, Nemko: Certificate No: P16221546, CB Test Certificate No : N094842



Innovations in Power

## Derating Curve

### Power de-rating

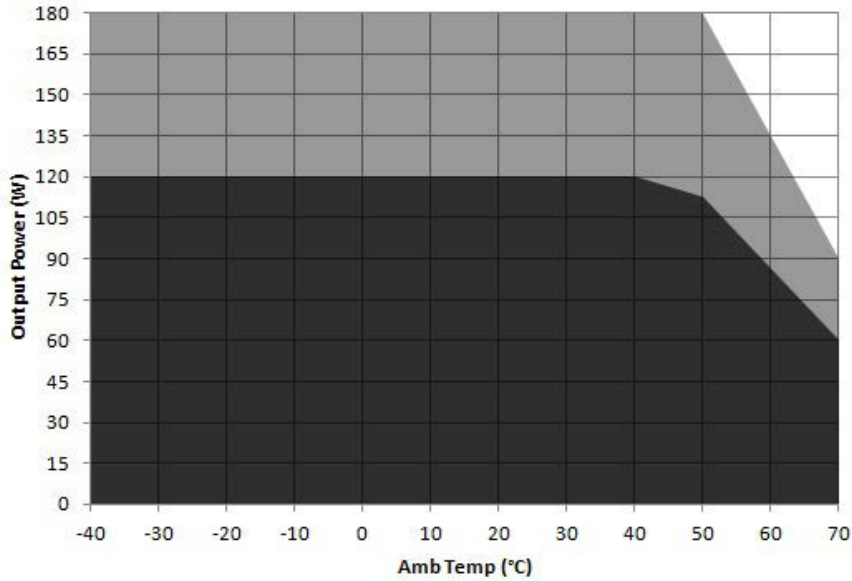

Convection load: 120W UP TO 40 °C  
 De-rate between 40-50 °C @ 0.625% per °C  
 De-rate above 50 °C @ 2.33% per °C

Forced air cooled load : 180W up to 50°C  
 De-rate above 50 °C @ 2.5% per °C

### Power de-rating : w.r.t. Input

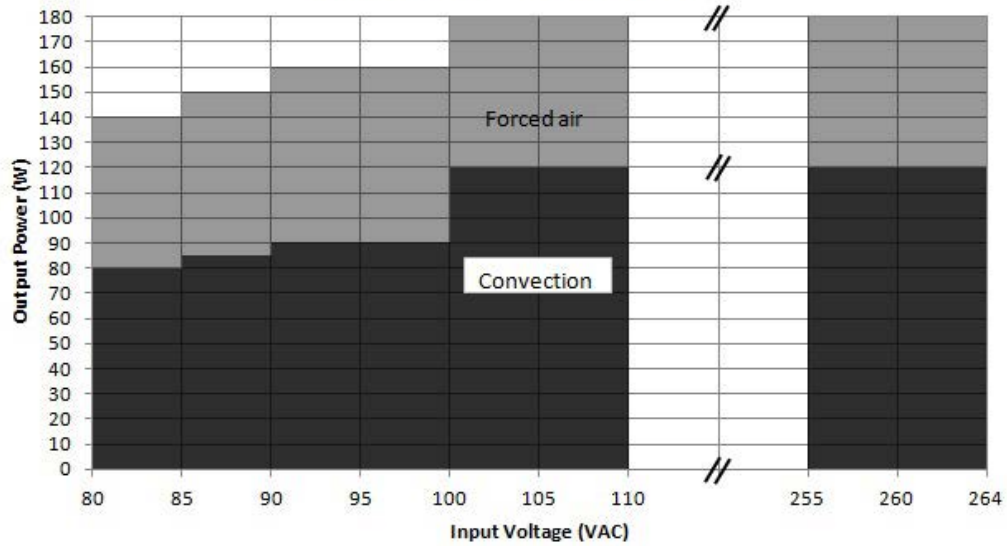

## Mechanical Drawing

### Option 1 (Without PGPF)

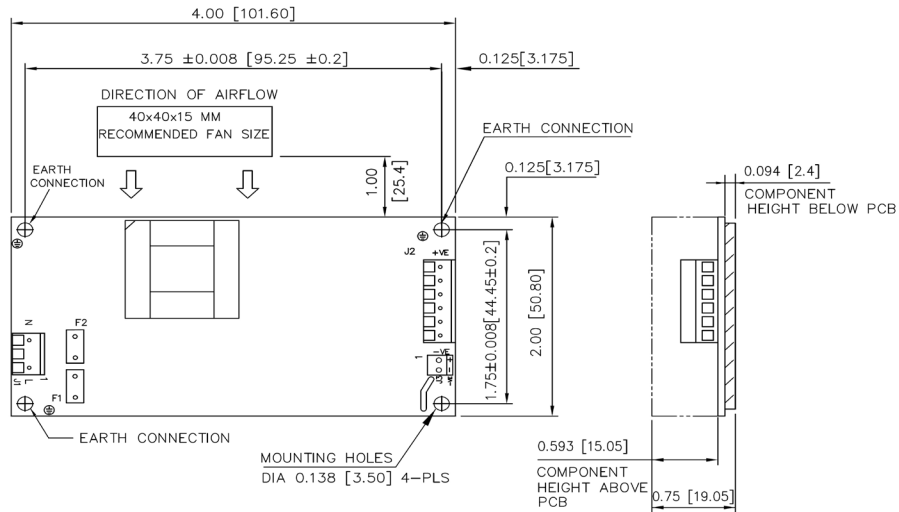

MECHANICAL OUTLINE DIMENSIONS  
ALL DIMENSIONS ARE IN INCHES[MM]  
GEN TOLERANCE : +/-0.04[+/-1.0MM]

- Notes: In case the PCB is mounted in a metal enclosure, using metal hardware ensure the following
1. Stand off, used to mount PCB has OD of 5.4 mm max.
  2. Screws, used to fix PCB on stand off, have head dia of 6.0 mm max.
  3. Washer, if used, to have dia of 6.5 mm max.

## Mechanical Drawing

### Option 2 (Without PGPF)

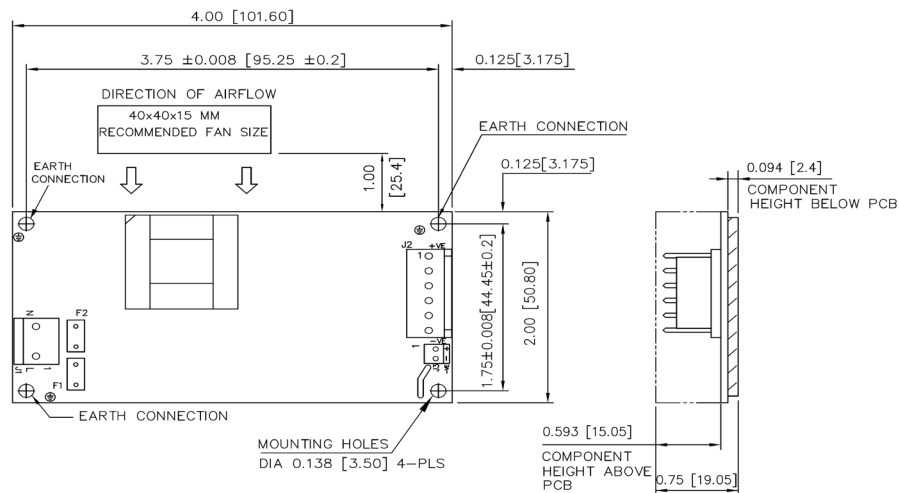

MECHANICAL OUTLINE DIMENSIONS  
ALL DIMENSIONS ARE IN INCHES[MM]  
GEN TOLERANCE : +/-0.04[+/-1.0MM]

- Notes: In case the PCB is mounted in a metal enclosure, using metal hardware ensure the following
1. Stand off, used to mount PCB has OD of 5.4 mm max.
  2. Screws, used to fix PCB on stand off, have head dia of 6.0 mm max.
  3. Washer, if used, to have dia of 6.5 mm max.

## Mechanical Drawing

### Option 3 (With PGPF)

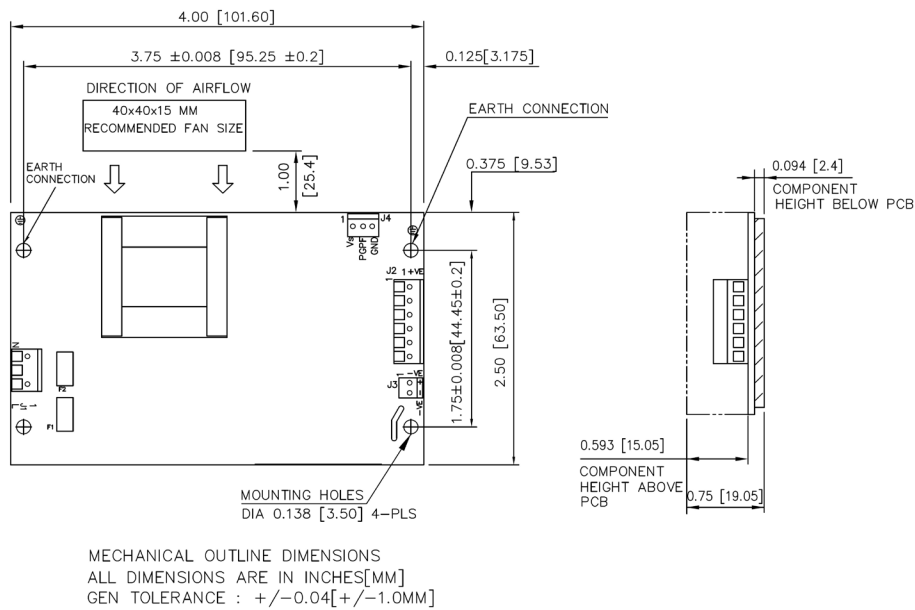

Notes: In case the PCB is mounted in a metal enclosure, using metal hardware ensure the following

1. Stand off, used to mount PCB has OD of 5.4 mm max.
2. Screws, used to fix PCB on stand off, have head dia of 6.0 mm max.
3. Washer, if used, to have dia of 6.5 mm max.

## Mechanical Drawing

### Option 4 (With PGPF)

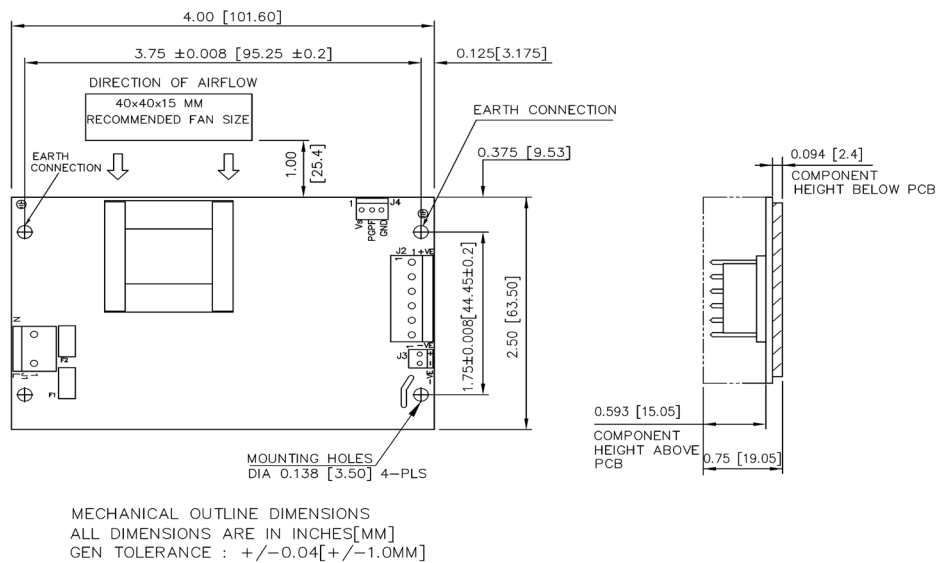

Notes: In case the PCB is mounted in a metal enclosure, using metal hardware ensure the following

1. Stand off, used to mount PCB has OD of 5.4 mm max.
2. Screws, used to fix PCB on stand off, have head dia of 6.0 mm max.
3. Washer, if used, to have dia of 6.5 mm max.